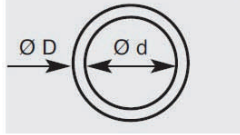

Hose Reel Enquiry Form

Hose quantity	<input type="checkbox"/> 1x single hose	<input type="radio"/>	<div style="border: 1px solid black; padding: 5px; width: fit-content;"> d = mm </div> 
	<input type="checkbox"/> 2x double hose	<input type="radio"/>	
	<input type="checkbox"/> 2x single hoses	<input type="radio"/>	
	<input type="checkbox"/> 1x triple hose	<input type="radio"/>	
	<input type="checkbox"/> Double + single hose	<input type="radio"/>	
	<input type="checkbox"/> 3x single hoses	<input type="radio"/>	
	<input type="checkbox"/> 2x double hose	<input type="radio"/>	

Hose reel type

Automatic spring driven un & rewinding

Manual unwinding and spring driven rewinding with lock system

Fluid	<input type="checkbox"/> Hydraulic oil	<div style="border: 1px solid black; padding: 5px; width: fit-content;"> Pressure </div>
	<input type="checkbox"/> Cold Water	
	<input type="checkbox"/> Hot Water	
	<input type="checkbox"/> Compressed air	
	<input type="checkbox"/> Other:.....	

max.= bar

Hose Length

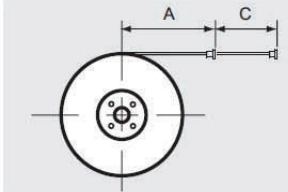

A = mm

C = mm

A = Useable hose length
C = Hose length not rewound

Direction of rotation

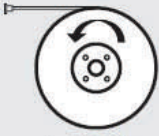

Left

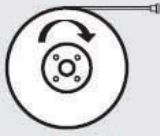

Right

Working direction

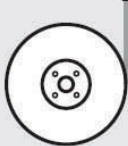

A

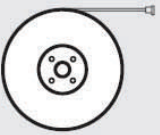

B

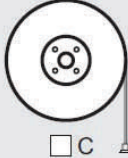

C

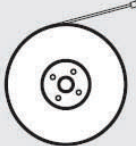

D

Contact details

Name: _____ Company: _____

Address: _____

Phone: _____

Fax: _____

Email: _____